

Grove for Scratch

Takoratch

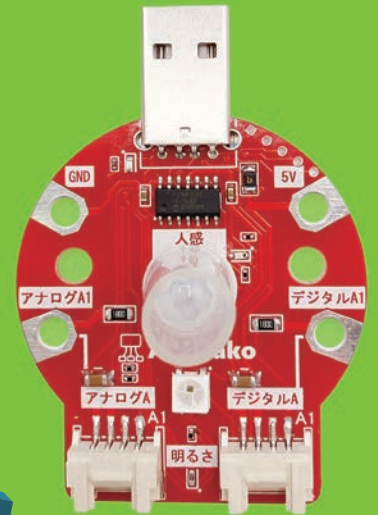

No batteries required

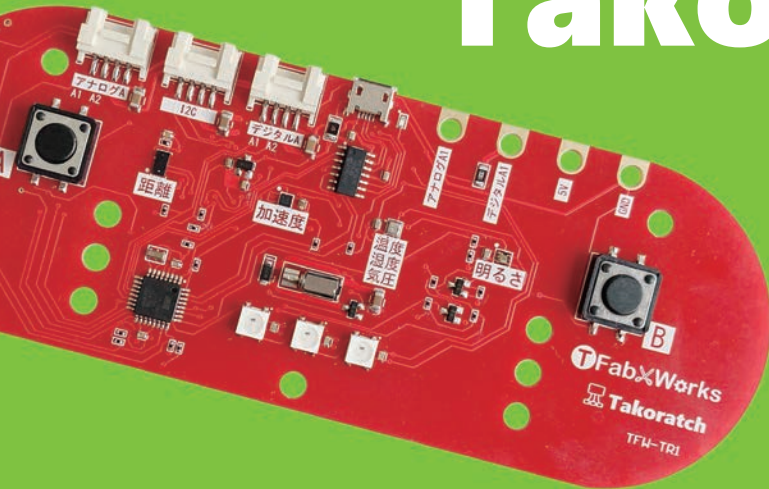
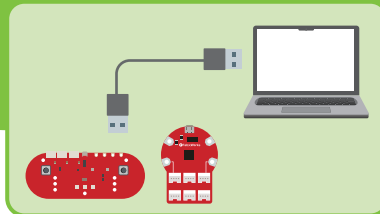

Works with a browser

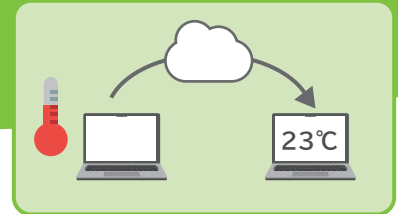

Transmission block is available in Scratch

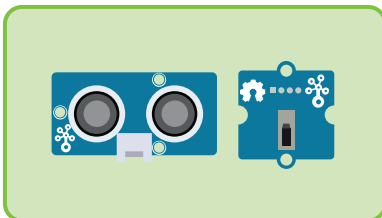

More than 50 Grove devices are available



No app installation required※1

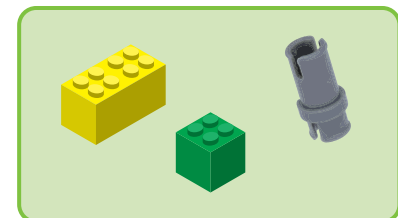

Compatible with LEGO Technic Pins

New Scratch Controller

Takoratch (TFW-TR1)

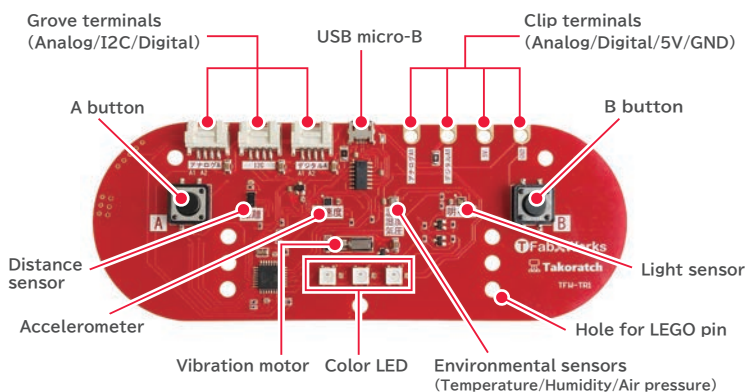

Entry model for AkaDako

Takoratch • mini (TFW-TM1)

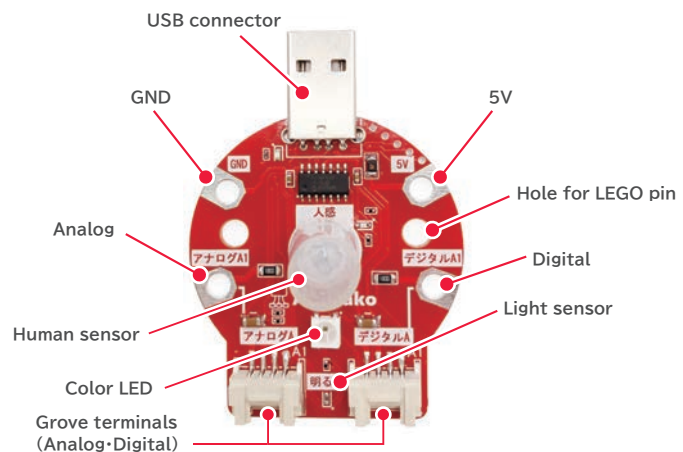

System requirements

Works on Xcratch and Stretch3. OS:Windows10/ChromeOS 89/iOS15 or later, AndroidOS and various Linux. Browser:Chrome 43/Edge 79/Scrub 1.1.1/Chrome for Android 113 or later. ※1. Scrub, a dedicated browser for Scratch must be installed on iPad.

AkaDako Extended Block

Connection

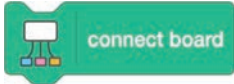

Temperature



Atmospheric pressure



Humidity



Brightness



Tilt



Distance

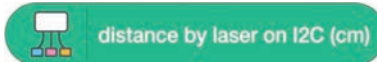

Motion



Digital

Input

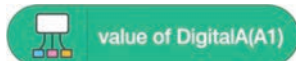

Output



Analog



We are using AkaDako series in Xcratch or Stretch3, which are Scratch compatible environment. See the following link to see for details.

<https://akadako.com/en/guide/>

Full color LED

Initialization



Setting



Lighting



Transmission

Sending

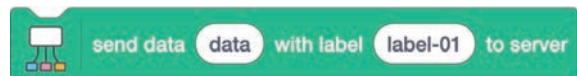

Receiving



Reference

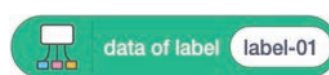

Vibration motor

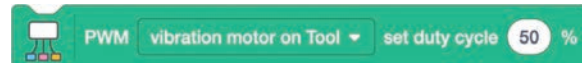

Servomotor



Button

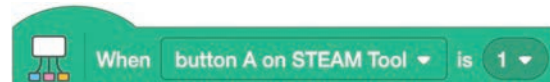

Purchase

All prices are tax included.



Takoratch · mini
TFW-TM1
¥2,970

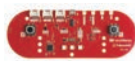

Takoratch
TFW-TR1
¥8,778



AkaDako2
TFW-AD2
¥3,278



AkaDako STEAM Tool
TFW-AT1
¥19,800



<https://akadako.com/en/purchase/>

Prices vary depending on the sales site.

Grove Devices

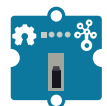

Grove devices available for AkaDako series are listed on the following link.

<https://akadako.com/en/grove/>